



Acoustical Surfaces, Inc.

Soundproofing, Acoustics, Noise & Vibration Control Specialists

123 Columbia Court North • Suite 201 • Chaska, MN 55318
(952) 448-5300 • Fax (952) 448-2613 • (800) 448-0121

Email: sales@acousticalsurfaces.com
Visit our Website: www.acousticalsurfaces.com

We Identify and **S.T.O.P.** Your Noise Problems

Acoustical Surfaces, Inc.
A Master Distributor for
PAC INTERNATIONAL, INC.



THE GARAGE DOOR SILENCER

Keep Your Home Quiet with

THE GARAGE DOOR SILENCER

Old Noisy Installation

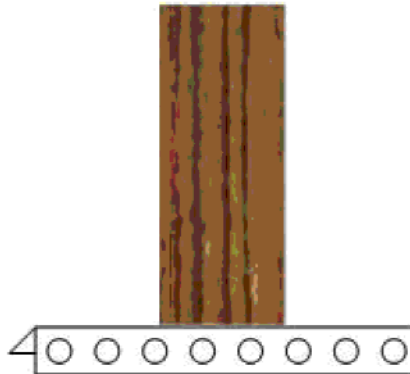

■ Perfect for homes with rooms
above or
adjacent to our garage

■ Full kit inside

■ No other parts needed

■ Easy to install

■ **NEW TECHNOLOGY**
Minimizes garage door opener
noise transmission

New Quiet Installation

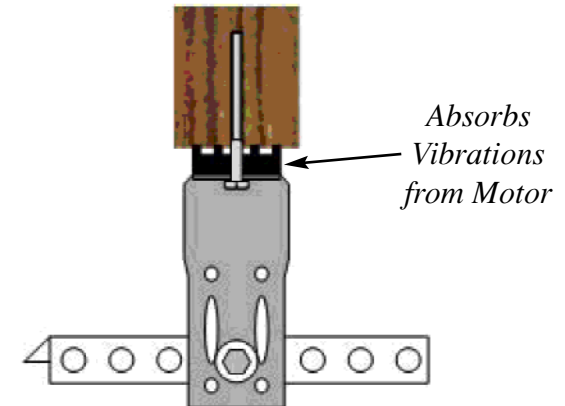



Acoustical Surfaces, Inc.

Soundproofing, Acoustics, Noise & Vibration Control Specialists

123 Columbia Court North • Suite 201 • Chaska, MN 55318
 (952) 448-5300 • Fax (952) 448-2613 • (800) 448-0121

Email: sales@acousticalsurfaces.com
 Visit our Website: www.acousticalsurfaces.com

We Identify and **S.T.O.P.** Your Noise Problems

Acoustical Surfaces, Inc.
 A Master Distributor for
 PAC INTERNATIONAL, INC.



THE GARAGE DOOR SILENCER

Parts List:

- | | |
|-------------------------------------|---------------------------|
| 1. 2 EA GARAGE DOOR SILENCERS (GDS) | 4. 2 EA 3/4" Long Bolts |
| 2. 4 EA 3" Hex Head Screws | 2. 2 EA 7/16" Nyloc Nuts |
| 3. 4 EA 1-1/2" Flat Washers | 3. 4 EA 3/4" Flat Washers |

Garage Door Motor Isolator Parts List

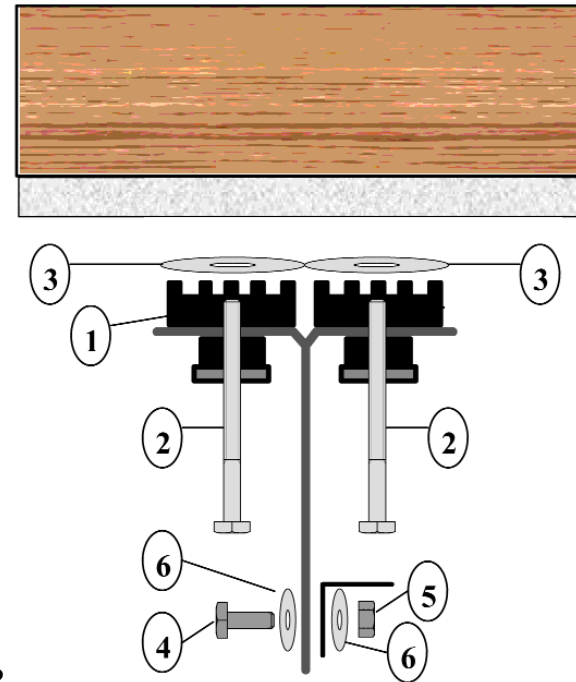
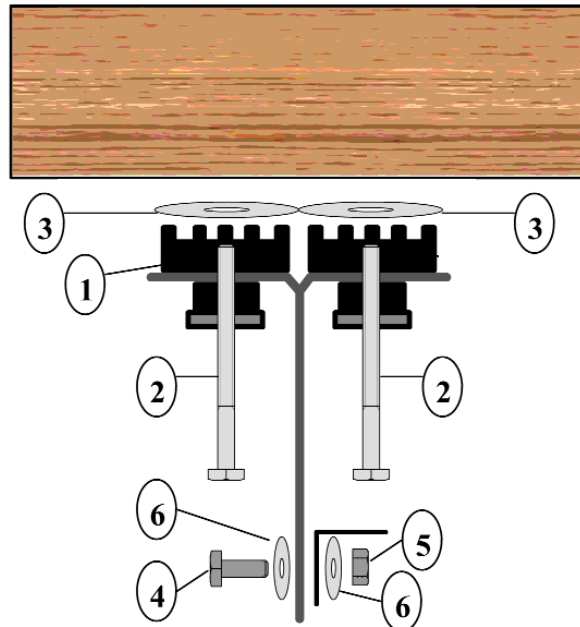



Acoustical Surfaces, Inc.

Soundproofing, Acoustics, Noise & Vibration Control Specialists

123 Columbia Court North • Suite 201 • Chaska, MN 55318
(952) 448-5300 • Fax (952) 448-2613 • (800) 448-0121

Email: sales@acousticalsurfaces.com
Visit our Website: www.acousticalsurfaces.com

We Identify and **S.T.O.P.** Your Noise Problems

Acoustical Surfaces, Inc.
A Master Distributor for
PAC INTERNATIONAL, INC.



THE GARAGE DOOR SILENCER

Installation Instructions (Steps 1-3 needed only if you adding the GDS garage door motor isolator clips to an already existing garage door opener system)

1. Disconnect power from garage door opener motor.
2. Disconnect metal brackets from the existing garage door opener motor. (Support garage door opener motor with ladder.)
3. Disconnect metal brackets from ceiling.
4. Install GARAGE DOOR SILENCERS using the 1-1/2" flat washers and the 3" hex head screws (screws need to be installed into the joist).
5. Trim 4" from the bottom of the metal support brackets to compensate for the 4" additional space that the GDS added.
6. Bolt the metal brackets from step 2 to the GDS isolators using the 3/4" bolt, 3/4" flat washers, and the 7/16" nyloc nut.
7. Reinstall the garage door opener motor to the metal brackets using the original hardware.
8. Plug in your garage door opener motor.

Guide for fasteners

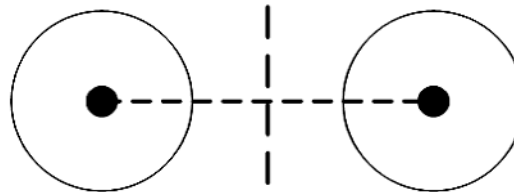



Acoustical Surfaces, Inc.

Soundproofing, Acoustics, Noise & Vibration Control Specialists

123 Columbia Court North • Suite 201 • Chaska, MN 55318
(952) 448-5300 • Fax (952) 448-2613 • (800) 448-0121

Email: sales@acousticalsurfaces.com
Visit our Website: www.acousticalsurfaces.com

We Identify and **S.T.O.P.** Your Noise Problems

Acoustical Surfaces, Inc.
A Master Distributor for
PAC INTERNATIONAL, INC.

THE GARAGE DOOR SILENCER

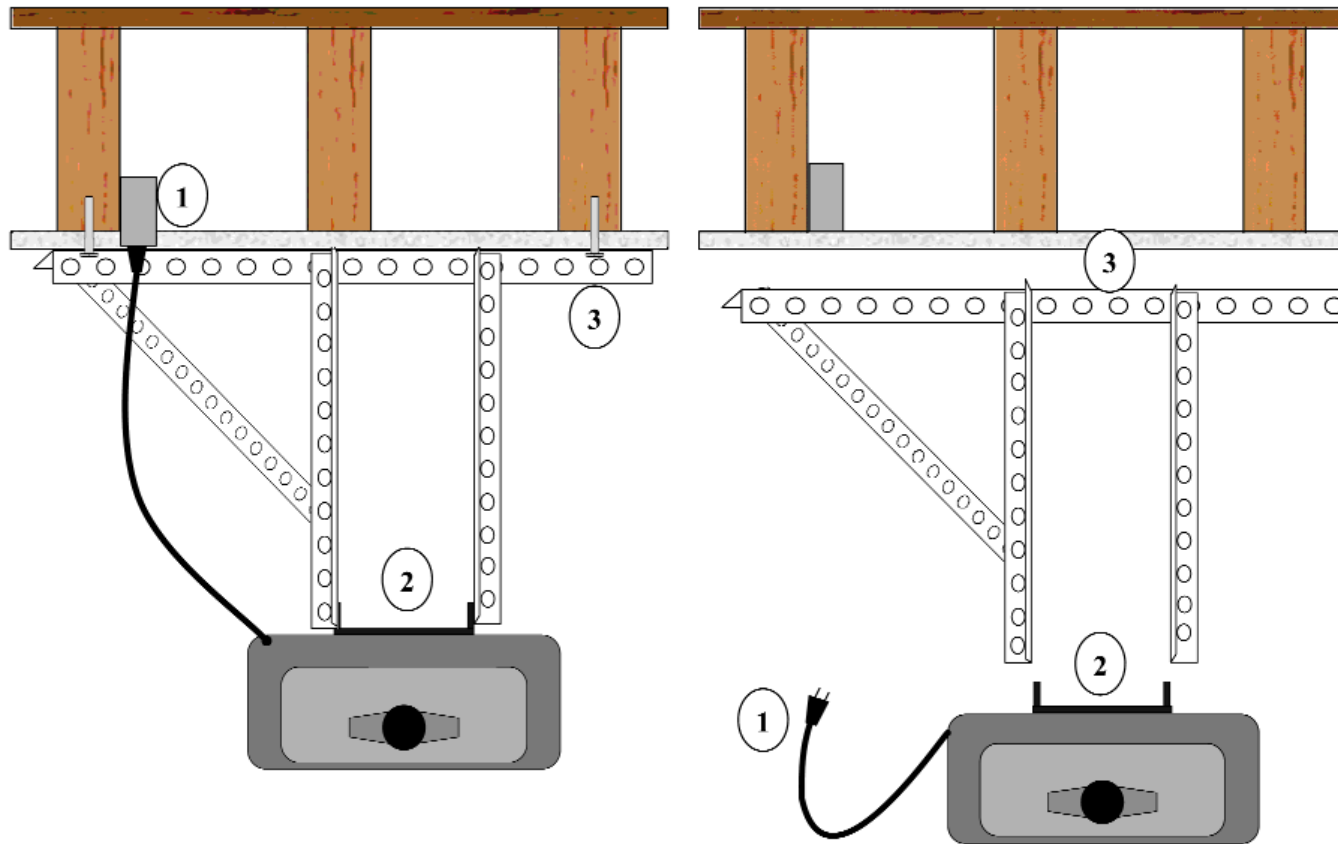



Acoustical Surfaces, Inc.

Soundproofing, Acoustics, Noise & Vibration Control Specialists

123 Columbia Court North • Suite 201 • Chaska, MN 55318
(952) 448-5300 • Fax (952) 448-2613 • (800) 448-0121

Email: sales@acousticalsurfaces.com
Visit our Website: www.acousticalsurfaces.com

We Identify and **S.T.O.P.** Your Noise Problems

Acoustical Surfaces, Inc.
A Master Distributor for
PAC INTERNATIONAL, INC.

THE GARAGE DOOR SILENCER

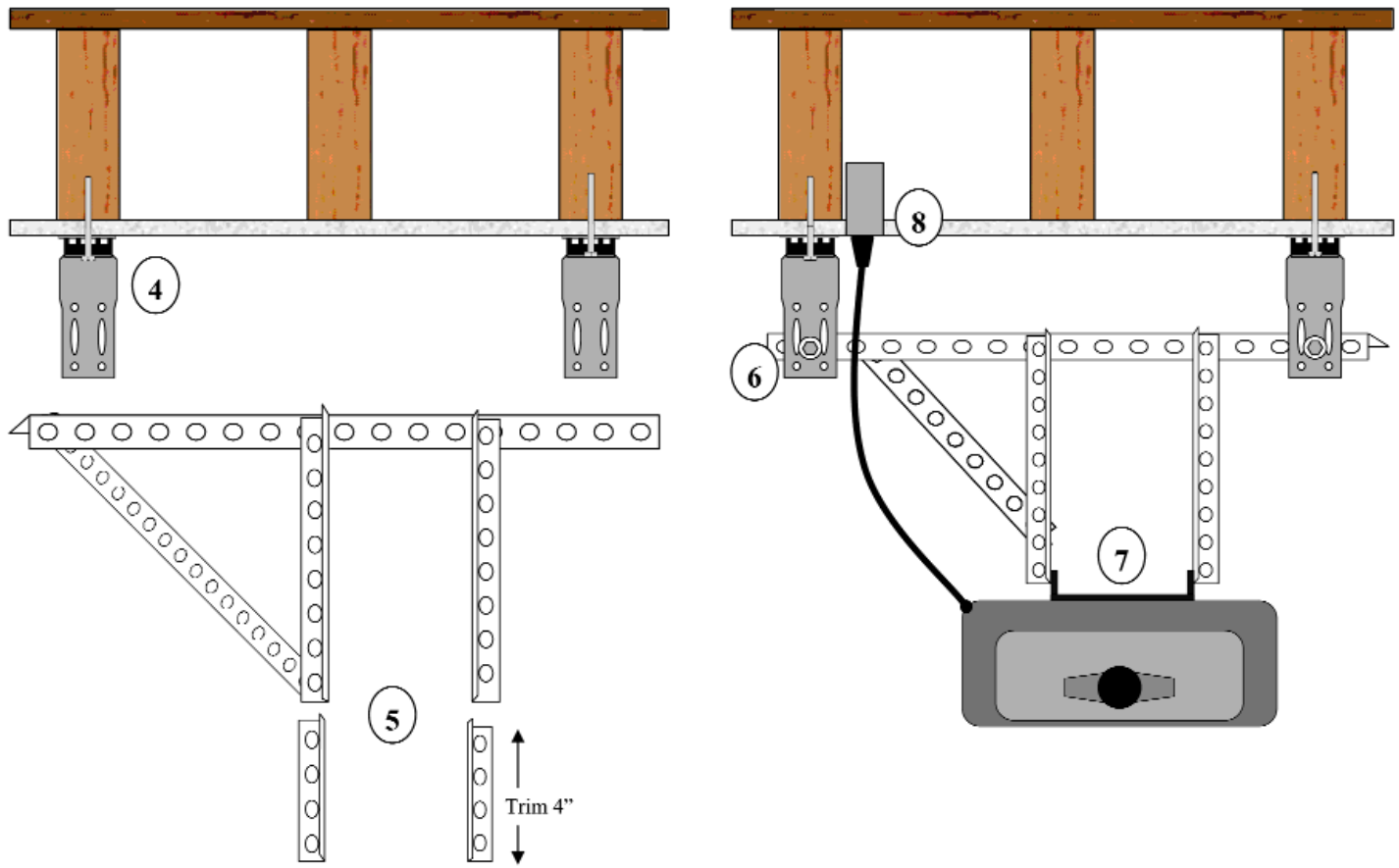



Acoustical Surfaces, Inc.

Soundproofing, Acoustics, Noise & Vibration Control Specialists

123 Columbia Court North • Suite 201 • Chaska, MN 55318
 (952) 448-5300 • Fax (952) 448-2613 • (800) 448-0121

Email: sales@acousticalsurfaces.com
 Visit our Website: www.acousticalsurfaces.com

We Identify and **S.T.O.P.** Your Noise Problems

Acoustical Surfaces, Inc.
 A Master Distributor for
PAC INTERNATIONAL, INC.

THE GARAGE DOOR SILENCER

